

POWERMATIC®

Operating Instructions and Parts Manual Rout-R-Lift® and Fence Assembly Item No. 6682004

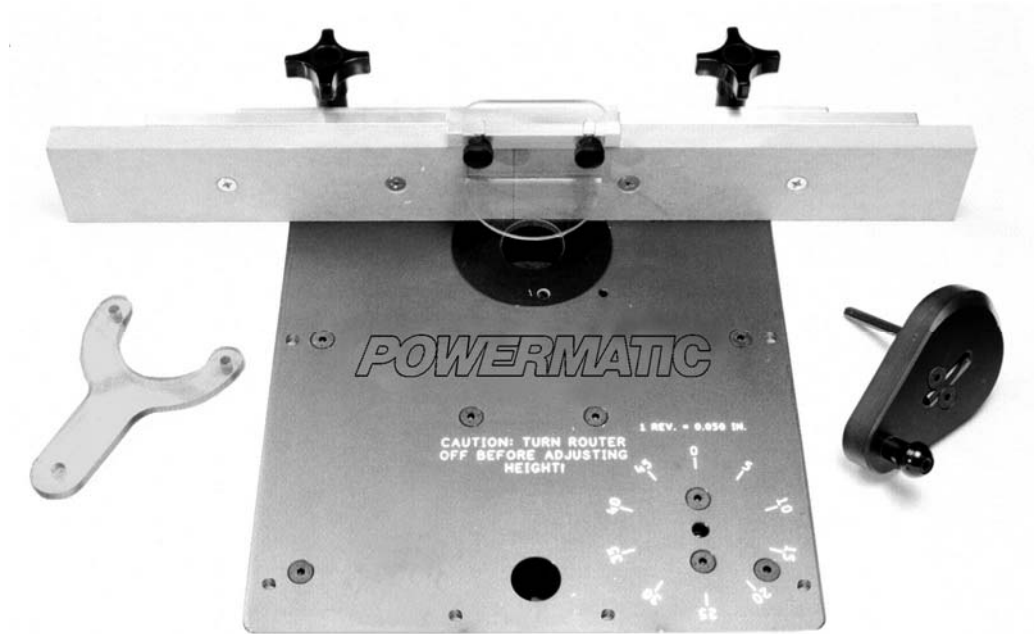

Powermatic
427 New Sanford Rd.
LaVergne, TN 37086
Ph.: 800-274-6848
www.powermatic.com

Part No. M-0460261
Revision D3 01/2014
Copyright © 2014 Powermatic

Warranty and Service

JET, Wilton and Powermatic warrants every product they sell against manufacturers' defects. If one of our tools needs service or repair, please contact Technical Service by calling 1-800-274-6846, 8AM to 5PM CST, Monday through Friday

Warranty Period

The general warranty lasts for the time period specified in the literature included with your product or on the official JET, Wilton or Powermatic branded websites.

- JET, Wilton and Powermatic products carry a limited warranty which varies in duration based upon the product. (See chart below)
- Accessories carry a limited warranty of one year from the date of receipt.
- Consumable items are defined as expendable parts or accessories expected to become inoperable within a reasonable amount of use and are covered by a 90 day limited warranty against manufacturer's defects.

Who is Covered

This warranty covers only the initial purchaser of the product from the date of delivery.

What is Covered

This warranty covers any defects in workmanship or materials subject to the limitations stated below. This warranty does not cover failures due directly or indirectly to misuse, abuse, negligence or accidents, normal wear-and-tear, improper repair, alterations or lack of maintenance.

Warranty Limitations

Woodworking products with a Five Year Warranty that are used for commercial or industrial purposes default to a Two Year Warranty. Please contact Technical Service at 1-800-274-6846 for further clarification.

How to Get Technical Support

Please contact Technical Service by calling 1-800-274-6846. **Please note that you will be asked to provide proof of initial purchase when calling.** If a product requires further inspection, the Technical Service representative will explain and assist with any additional action needed. JET, Wilton and Powermatic have Authorized Service Centers located throughout the United States. For the name of an Authorized Service Center in your area call 1-800-274-6846 or use the Service Center Locator on the JET, Wilton or Powermatic website.

More Information

JET, Wilton and Powermatic are consistently adding new products. For complete, up-to-date product information, check with your local distributor or visit the JET, Wilton or Powermatic website.

How State Law Applies

This warranty gives you specific legal rights, subject to applicable state law.

Limitations on This Warranty

JET, WILTON AND POWERMATIC LIMIT ALL IMPLIED WARRANTIES TO THE PERIOD OF THE LIMITED WARRANTY FOR EACH PRODUCT. EXCEPT AS STATED HEREIN, ANY IMPLIED WARRANTIES OF MERCHANTABILITY AND FITNESS FOR A PARTICULAR PURPOSE ARE EXCLUDED. SOME STATES DO NOT ALLOW LIMITATIONS ON HOW LONG AN IMPLIED WARRANTY LASTS, SO THE ABOVE LIMITATION MAY NOT APPLY TO YOU.

JET, WILTON AND POWERMATIC SHALL IN NO EVENT BE LIABLE FOR DEATH, INJURIES TO PERSONS OR PROPERTY, OR FOR INCIDENTAL, CONTINGENT, SPECIAL, OR CONSEQUENTIAL DAMAGES ARISING FROM THE USE OF OUR PRODUCTS. SOME STATES DO NOT ALLOW THE EXCLUSION OR LIMITATION OF INCIDENTAL OR CONSEQUENTIAL DAMAGES, SO THE ABOVE LIMITATION OR EXCLUSION MAY NOT APPLY TO YOU.

JET, Wilton and Powermatic sell through distributors only. The specifications listed in JET, Wilton and Powermatic printed materials and on official JET, Wilton and Powermatic-branded websites are given as general information and are not binding. JET, Wilton and Powermatic reserve the right to effect at any time, without prior notice, those alterations to parts, fittings, and accessory equipment which they may deem necessary for any reason whatsoever. JET® branded products are not sold in Canada by JPW Industries, Inc.

Product Listing with Warranty Period

90 Days – Parts; Consumable items; Light-Duty Air Tools
1 Year – Motors; Machine Accessories; Heavy-Duty Air Tools; Pro-Duty Air Tools
2 Year – Metalworking Machinery; Electric Hoists, Electric Hoist Accessories
5 Year – Woodworking Machinery
Limited Lifetime – Wilton branded products; JET Parallel clamps; Manual Hoists; Manual Hoist Accessories; Shop Tools; Warehouse & Dock products; Hand Tools

NOTE: JET, Wilton and Powermatic are divisions of JPW Industries, Inc.. References in this document to JET, Wilton and/or Powermatic also apply to JPW Industries, Inc., or any of its successors in interest to the JET, Wilton and/or Powermatic brands.

Table of Contents

- Warranty and Service 2
- Table of Contents 3
- Mounting Your Router to the Rout-R-Lift 4
- Leveling the Rout-R-Lift 6
- Mounting the Deluxe Fence Assembly 7
- Using Your Rout-R-Lift 9
- Modification for Height Adjustment Tension 10
- Replacement Parts 10
 - Rout-R-Lift Deluxe Fence Assembly 11
 - Rout-R-Lift Assembly – Exploded View 12
 - Rout-R-Lift Assembly – Parts List 13
- Router Hole Patterns 14
- Router Hole Patterns (continued) 15
- Making a Cut-out for the Rout-R-Lift 15

⚠WARNING Disconnect the table saw from the power source before attempting any assembly or adjustment. Failure to comply may cause serious injury.

Contents of the Shipping Container

- 1 Rout-R-Lift
 - 1 Adjustment Handle
 - 1 Phenolic Insert 1-1/2"
 - 1 Insert Wrench
 - 1 5/32 Hex Wrench
 - 1 1/8 Hex Wrench
- 10 1/4-28 Socket Set Screws
 - 1 Starting Pin
 - 1 Aluminum Fence Bracket
 - 2 Aluminum Fence Extensions
 - 2 MDF Sub Fences
 - 1 Hardware Package
 - 2 Fence Clamping Knobs
 - 2 Guard Clamping Knobs
 - 1 Plastic Fence Guard
 - 1 Assembly Instructions
 - 1 Warranty Registration Card

Additional tools required to mount your router to the Rout-R-Lift:

Cross-point (Phillips) screwdriver

Tools required for adjustment:

7/16" Open End Wrench

Mounting Your Router to the Rout-R-Lift

1. Turn your Rout-R-Lift upside down on the table. With the 5/32 hex wrench supplied, remove the four 1/4-20 x 1 flat head cap screws (Figure 1) and remove the aluminum carriage plate. (NOTE: If the screws are blocked, crank the Rout-R-Lift with the adjustment handle until all four screws are exposed.)
2. Remove the master ring from the carriage plate, by first removing the six 1/4-20 x 3/4 flat head machine screws that secure the clamping brackets to the aluminum carriage plate (Fig. 2).
3. Remove the sub-base and screws that attach the sub-base to your router. NOTE: If your sub-base cannot be removed, just remove the screws that will be used to attach your router to the master ring.
4. Lay the master ring on a flat surface with the countersunk holes and the engraving facing upwards and with the **engraved "T" to the top and the engraved "B" to the bottom.**

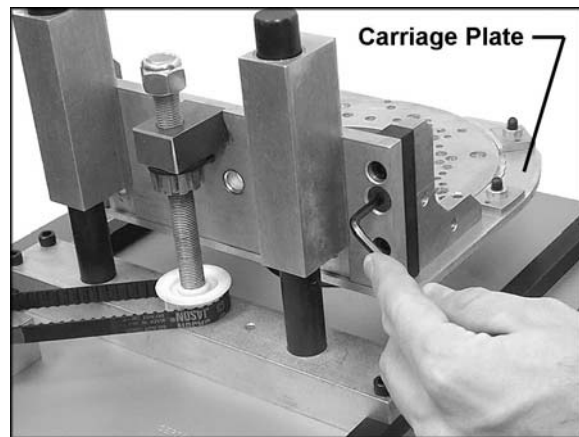

Figure 1

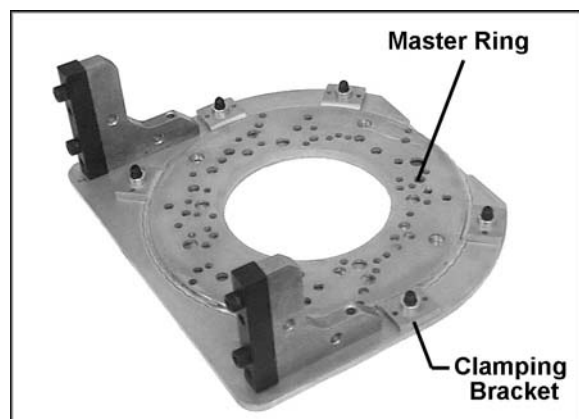

Figure 2

5. Pages 14-15 show a series of drawings of the master ring with the holes shaded solid to match many different routers. Locate your router and then locate the proper holes in the master ring using the drawing as an aid. With a felt tip marker or pencil, mark a line on the master ring for each hole that you will be using for your router.

6. With the holes marked on the master ring, place the master ring on the base of your router and rotate it to line up the correct holes in your router. Don't worry about handle location at this point as that can be set when the master ring is re-attached to the aluminum carriage plate.

7. The master ring is 1/4" thick and may prevent your screws that come with your router from engaging your router sufficiently. If this is the case, source longer flat head screws from your local hardware or automotive parts supplier. With the screws you removed from your router (or the longer screws which you acquired) attach the master ring to your router (Fig. 3). Lightly secure the screws at first to ensure that the master ring will locate in the center of your router, and then tighten securely.



Figure 3

8. You must now re-attach the master ring to the aluminum carriage plate. With the carriage plate upside down in front of you, slide the master ring with router attached into place to engage the recess of the carriage plate (Fig. 4).

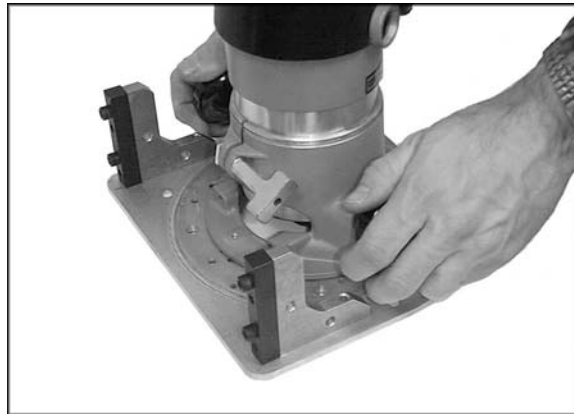

Figure 4

At this point, take note of the handle location and on/off switch to ensure they are in the best location for use. You can rotate the router at this point to have it in the best possible location for use. Once satisfied with the router location, place one of the clamping brackets into the correct location and feed one of the 1/4-20 x 3/4" flat head screws from under the aluminum carriage plate and thread into the clamping bracket. Repeat this step for the other five clamping brackets.

9. Once the brackets are in place, securely tighten the six 1/4-20 x 3/4" screws.

- Using the 1/4-20 x 1" flat head screws (removed in step 1), re-install the carriage to the Rout-R-Lift (Fig. 5). NOTE: Use the socket head cap screws as locating pins for easier installation of the carriage.

Your router should now be installed onto the Rout-R-Lift.

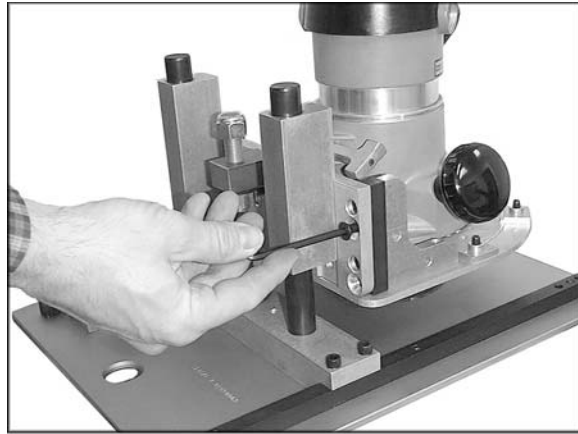

Figure 5

NOTE: It is unlikely that your router will not fit one of the hole patterns on the master ring. However, if it will not match, new holes will have to be drilled. Proceed as follows:

- Remove the master ring from the carriage plate (see step #2 above) and place it engraved side down.
- Center your router's sub-base onto the master ring, and rotate the sub-base until there is minimal interference with any of the pre-drilled holes in the ring.
- Clamp the sub-base to the master ring and use the sub-base holes as a template to drill the holes into the master ring. Use a bit slightly larger than your sub-base screws.
- Remove the clamps and flip the master ring over so the engraved side with the "T" and "B" is now face up.
- Countersink the holes to suit the router's flat head screws. (NOTE: If the router you are mounting does not have flat head screws holding the sub-base, then source flat head screws that match at a local supplier.)
- Continue the assembly process according to the instructions under "Mounting Your Router..."

Leveling the Rout-R-Lift

Included with your Rout-R-Lift are ten 1/4-28 set screws and 1/8 hex wrench. These set screws can be used to level your Rout-R-Lift to the table; thread the set screws into the ten tapped holes in your Rout-R-Lift from above using the 1/8 hex wrench provided (Fig. 6).

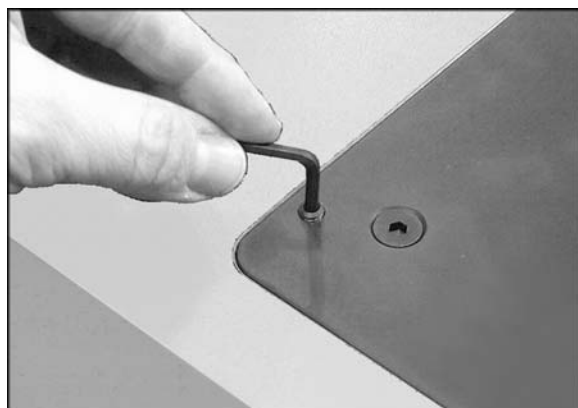

Figure 6

Mounting the Deluxe Fence Assembly

1. Take the three button head Phillips screws and put one through each hole on the vertical side of the aluminum fence support (Fig. 7). There are three holes on each side of the fence support; do one side at a time. Start the square nuts on each screw. Do not tighten, leave loose for installation.

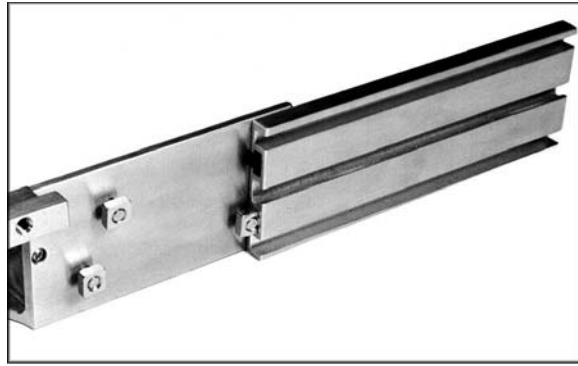

Figure 7

2. Take one fence extension assembly and install onto the fence support (Fig. 8). The holes are staggered for easy installation.

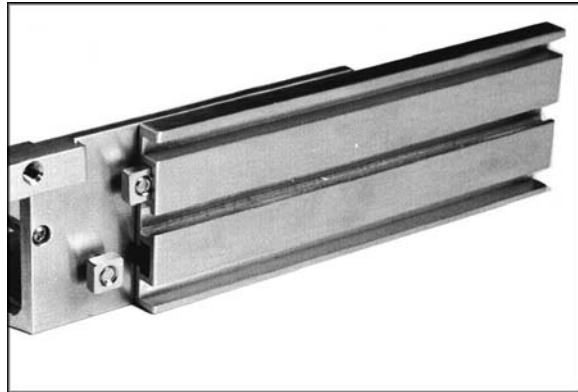

Figure 8

3. Slide assembly along the fence support until it stops at the fence guard bridge (Fig. 9). Securely fasten the screws.

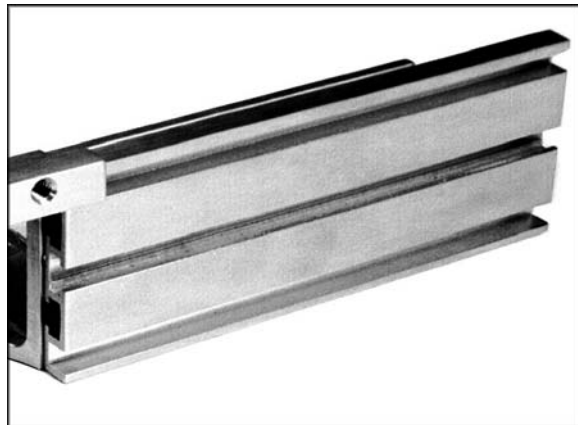

Figure 9

4. Take the remaining three button head Phillips screw and perform steps 1, 2 and 3 on the other side of the fence support.

5. Install the 1/4-20 x 1 flat head screws and square nuts into the holes in the MDF Subfences, leaving clearance under the nuts. Mount the Subfence by sliding the nuts into the T-Slot of the fence extension (Fig. 10).

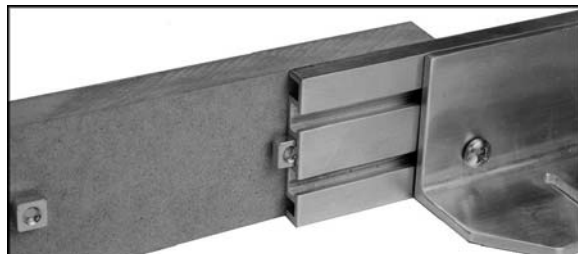

Figure 10

NOTE: The MDF Subfences can be mounted either on the left or right but the screws should be closest to the center of the fence once installed (Fig. 11).

The sub-fence is adjusted by loosening the two flat head screws on the front of each MDF board. Once loosened, slide the board to the desired opening. Securely tighten the flat head screws.

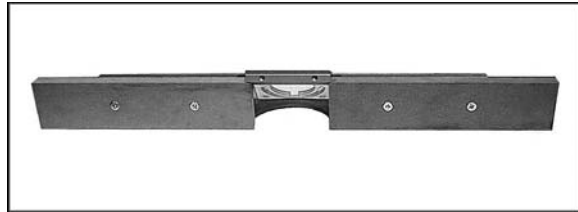

Figure 11

6. Mount the adjustable fence guard to the bridge on the fence bracket with the two fence guard knobs (Fig. 12).

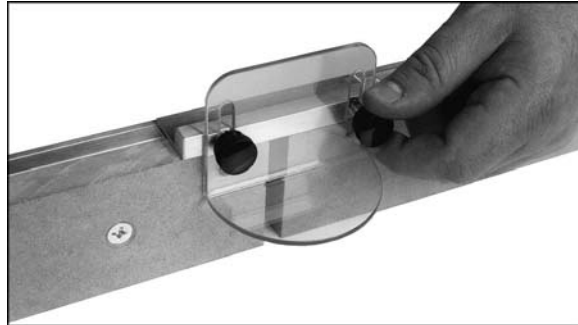

Figure 12

7. Mount the assembled fence to the main plate of the ROUT-R-LIFT with one fence knob in each of the threaded holes in the top corners of the plate (Fig. 13).

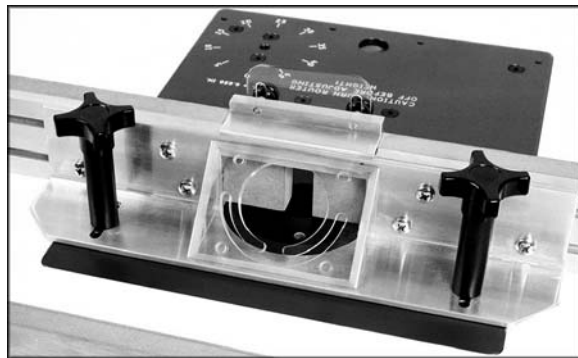

Figure 13

8. The vacuum attachment is sized to accept standard 2-1/4" vacuum hose or a dust collector adaptor (see your local Powermatic dealer for adaptors). To install hose on the vacuum attachment, press nozzle down slightly on the flexible arms and pivot inward (Fig. 14).

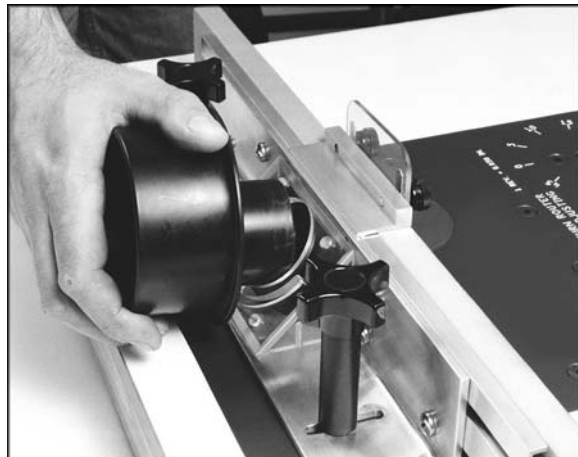

Figure 14

Using Your Rout-R-Lift

CAUTION Always turn router off and disconnect router from power source before making any height adjustment.

1. Depending on the size of the router bit you are using it may be desirable to use an insert ring to reduce the size of the opening. To install the insert ring place the insert into the opening of the main plate, then with the insert wrench turn counterclockwise to tighten (then remove the insert wrench). See Fig. 15.



Figure 15

2. With the router bit installed, place the adjustment handle into the access port in the main plate (Fig. 16).

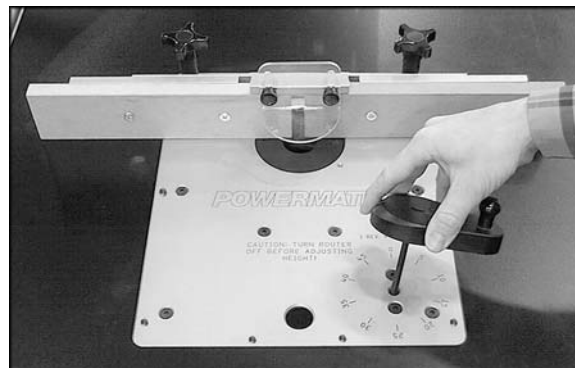

Figure 16

3. Bring the bit flush to the table top.

4. To raise your router, turn the adjustment handle clockwise; to lower turn the adjustment handle counterclockwise. Keep in mind that one complete revolution of the adjustment handle equals 0.050" or 1/20". See Fig. 17.

<u>Fraction</u>	<u>Decimal</u>	<u>Number of Revolutions</u>
1/64"	0.016	
1/32"	0.031	
1/16"	0.062	1 and 1/4 revolutions
1/8"	0.125	2 and 1/2 revolutions
1/4"	0.250	5 revolutions
1/2"	0.500	10 revolutions

Figure 17

5. Make the desired height adjustment. When your adjustment is complete, remove the adjustable handle.

6. A starting pin is provided to assist in certain freehand operations when the fence is not used. Thread the pin into the router plate with a screwdriver (Fig. 18).

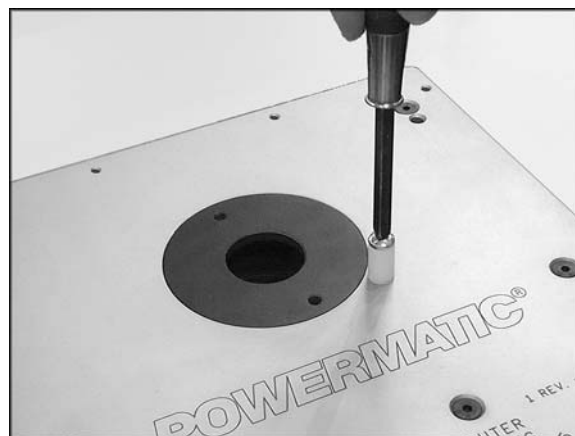

Figure 18

Modification for Height Adjustment Tension

⚠WARNING Disconnect router from power source.

The height adjustment tension is set at the factory; however, if you find the tension is too loose and the router's height adjustment moves when routing, then modification is as follows:

1. Turn your Rout-R-Lift upside down on a table (Fig. 19).
2. With a 7/16 open end wrench, loosen the 1/4-20 hex nut (Fig. 20). Then back out the set screw with the 1/8 hex wrench.
3. Rotate the brass anti-backlash nut so it tightens against the rubber washer (Fig. 21). NOTE: A drop of oil on the rubber washer eases the rotation of the brass nut against the washer.
4. Make certain when you have finished tightening the brass anti-backlash nut that one of the slots on the nut is centered to the set screw. This ensures that the set screw will protrude into the slot of the anti-backlash nut. See Fig. 21.
5. Snug the set screw, then tighten the 1/4-20 hex nut (that you loosened in step 2).

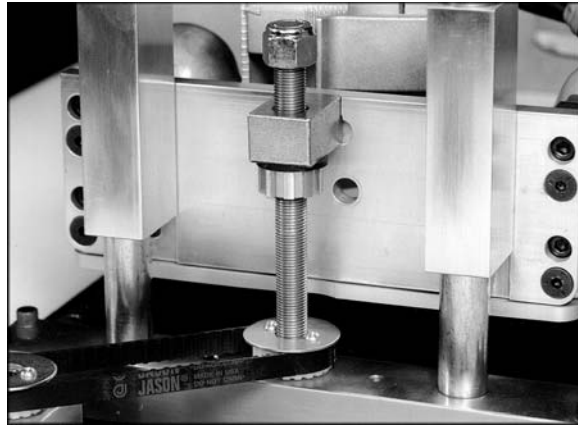

Figure 19

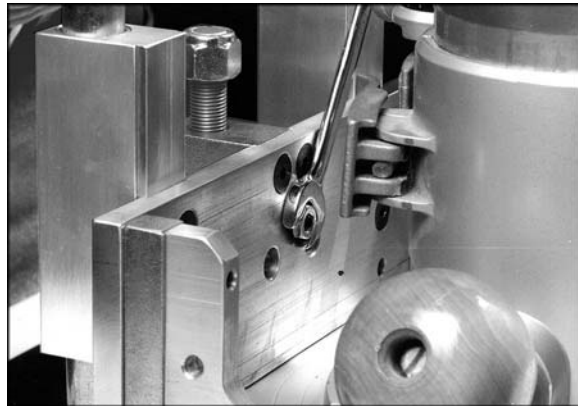

Figure 20

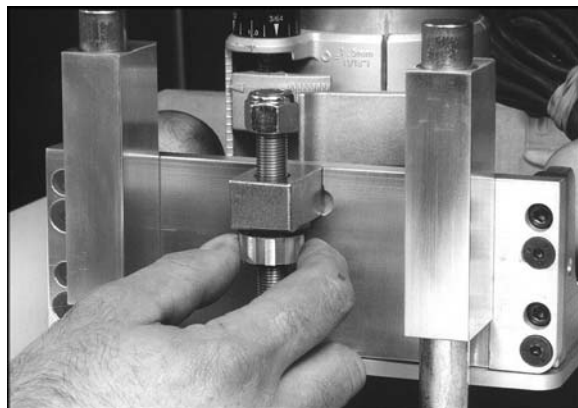
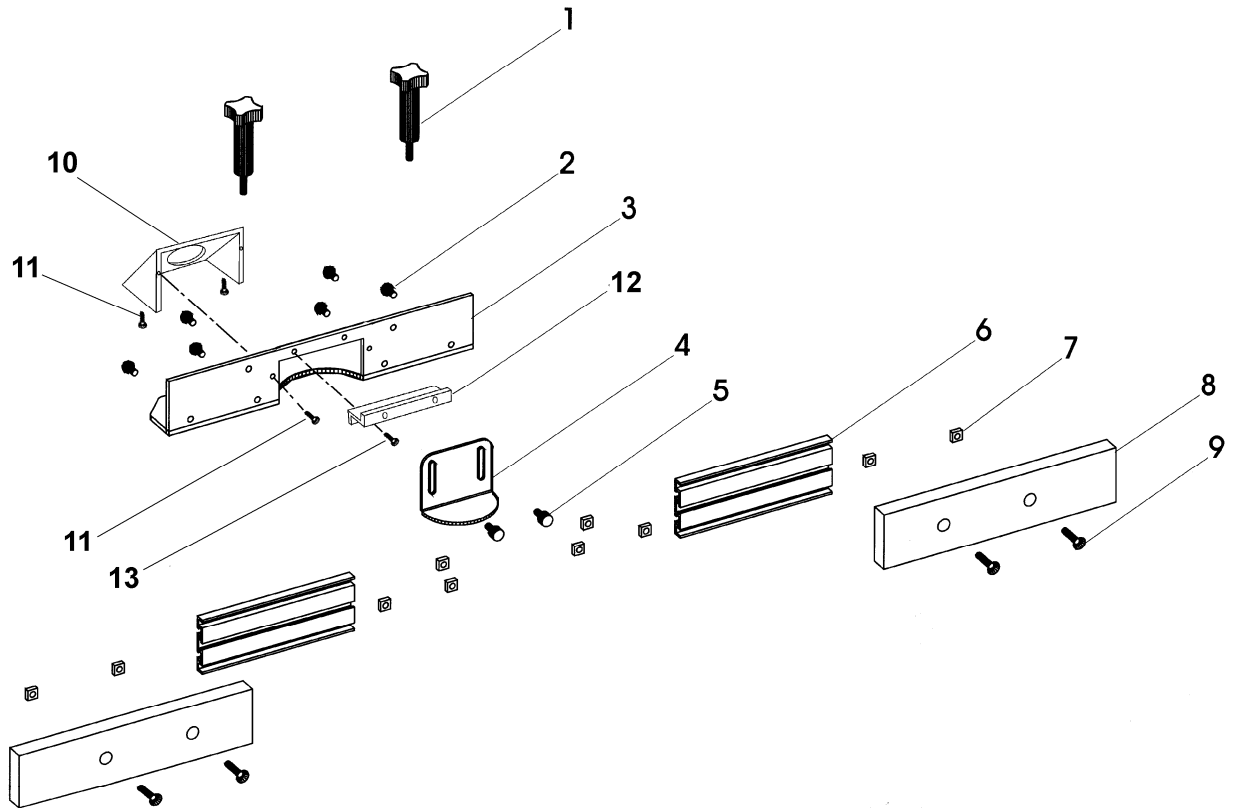

Figure 21

Replacement Parts

Replacement parts listed on the following pages. To order parts or reach our service department, call 1-800-274-6848, Monday through Friday (see our website for business hours, www.powermatic.com). Having the Model Number and Serial Number of your machine available when you call will allow us to serve you quickly and accurately.

Rout-R-Lift Deluxe Fence Assembly



Index No.	Part No.	Description	Size	Qty
	6682004F	Rout-R-Lift Deluxe Fence (Items 1 thru 13)		
1	XLIFT-M0026	Fence Clamping Knobs		2
2	XLIFT-E0040	Button Head Screw	1/4-20 x 1/2"	6
3	PLIFT-E0032	Aluminum Fence Bracket	2-1/2" x 2-1/2" x 3/16" x 14"	1
4	XLIFT-M0039	Fence Guard	1/8 Polycarbonate	1
5	XLIFT-M0028	Guard Clamping Knob		2
6	PLIFT-E0030	Aluminum Fence Extension	7/16" x 2-1/2" x 7"	2
7	XLIFT-F0028	Square Nut	1/4-20	10
8	XLIFT-M0040	MDF Sub Fences	3/4" x 2-1/2" x 10-3/4"	2
9	XLIFT-F0017	Flat Head Screws	1/4-20 x 1"	4
10	XLIFT-E0032A	Plastic Dust Collector Connector		1
11	TS-081A032	Pan Head Phillips Machine Screw	#6-32 x 1/2"	4
12	PLIFT-E0032B	Aluminum Safety Guard Bracket		1
13	TS-081A012	Pan Head Phillips Machine Screw	#6-32 x 1/4"	2

Rout-R-Lift Assembly – Exploded View

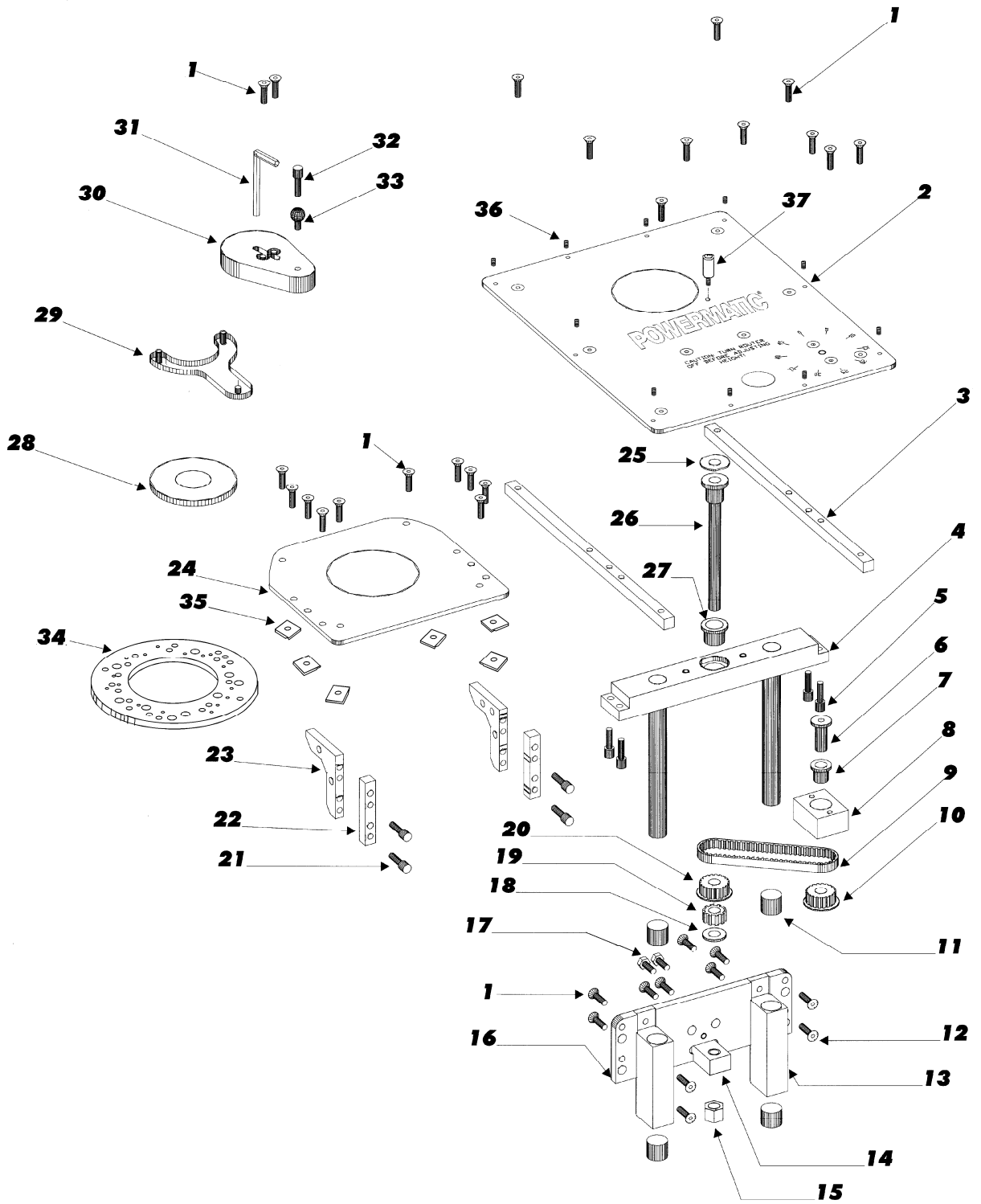

Rout-R-Lift Assembly – Parts List

Index No.	Part No.	Description	Size	Qty
1	XLIFT-F0001	Flat Head Cap Screw	1/4-20 x 3/4	28
2	PLIFT-P0003-1	Aluminum Main Plate	14-3/4 x 11-3/4 x 1/4	1
3	XLIFT-S0001-1	Steel Side Supports	1/2 x 1/2 x 13-1/4	2
4	XLIFT-E0001-1	Aluminum Shaft Mounting Block	1 x 1-1/2 x 10.1	1
5	XLIFT-F0002	Socket Head Cap Screw	1/4-20 x 7/8	4
6	XLIFT-M0001	Steel Drive Pulley Spindle		1
7	XLIFT-M0006	Bronze Flange Bearing	3/4 x 7/8 x 3/4	1
8	XLIFT-E0001-2	Drive Pulley Mounting Block	1 x 1-1/2 x 2	1
9	XLIFT-M0011	Rubber Timing Belt	130 XL x 3/8	1
10	XLIFT-M0005	Drive Pulley (Delrin)	20 XL x 3/8	1
11	XLIFT-M0009	Bronze Sleeve Bearing	3/4 x 7/8 x 3/4	4
12	XLIFT-F0005	Flat Head Cap Screw	1/4-20 x 1	4
13	XLIFT-E0001-3	Aluminum Bearing Mounts	1 x 1-1/2 x 4	2
14	XLIFT-S0002-1	Steel Carriage Nut	3/4 x 1 x 1-1/2	1
15	XLIFT-F0003	Nylon Insert Lock Nut	1/2-20	1
16	XLIFT-E0002-1	Aluminum Carriage Bracket	3/8 x 3 x 8-1/2	1
17	XLIFT-F0006	Half Dog Pt. Set Screw (Anti-Backlash)	1/4-20 x 1	1
18	XLIFT-M0012	Rubber Washer	1/2 x 1-1/16 x .093	1
19	XLIFT-M0003	Brass Anti-Backlash Nut	1 x .450 x 1/2-20	1
20	XLIFT-M0004	Threaded Pulley (Delrin)	20 XL w/ 1/2-20	1
21	XLIFT-F0004	Socket Head Cap Screw	1/4-20 x 1	4
22	XLIFT-S0001-2	Carriage Mounting Block	1/2 x 1/2 x 3 Steel	2
23	XLIFT-E0002-2	Aluminum Carriage Gusset	3/8 x 2-1/2 x 3	2
24	XLIFT-P0002	Aluminum Carriage Plate	7.9 x 8-1/2 x 3/16	1
25	XLIFT-M0007	Bronze Thrust Washer	9/16 x 1-1/4 x 1/16 thk	1
26	XLIFT-M0042	Carriage Lead Screw		1
27	XLIFT-M0008	Bronze Flange Bearing	1/2 x 5/8 x 3/4 Lg	1
28	XLIFT-M0017-1	Phenolic Insert Ring	1-1/2 hole opening	1
29	XLIFT-M0016-1	Insert Wrench		1
30	XLIFT-M0018	Lift Handle (Arboron)		1
31	XLIFT-M0015	Hex Key	1/4	1
32	XLIFT-F0007	Socket Head Cap Screw	1/4-20 x 1-1/4	1
33	XLIFT-M0041-1	Phenolic Lift Handle Knob	1/4" Cored Hole	1
34	XLIFT-P0009	Master Ring		1
35	XLIFT-P0011	Master Ring Clamp		6
36	XLIFT-F0008	Oval Point Socket Set Screw	1/4-28 x 1/4	10
37	XLIFT-P0012	Starter Pin		1

Router Hole Patterns

The following is a series of hole patterns for various routers as noted in Step 5 of "Mounting Your Router." Locate the name and correct model number of your router and then locate the holes in the master ring. With a felt tip marker or pencil mark a line on the master ring for each hole you will be using for your router.

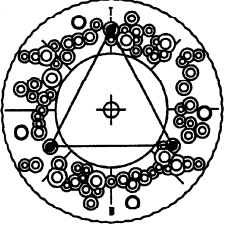
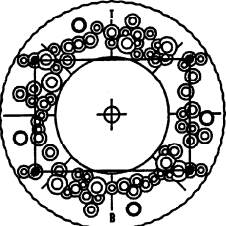
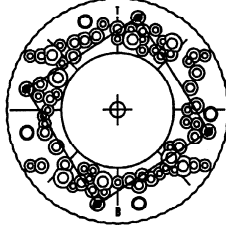
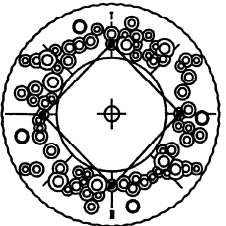
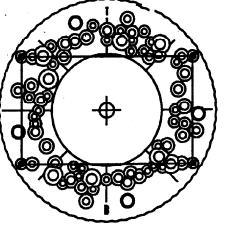
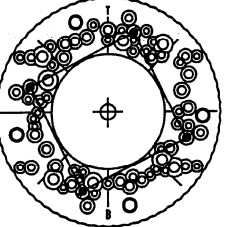
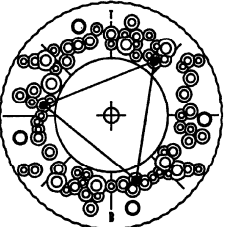
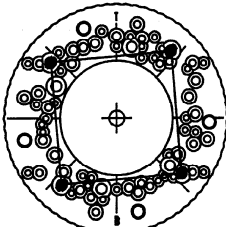
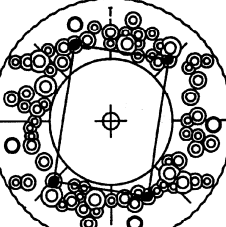
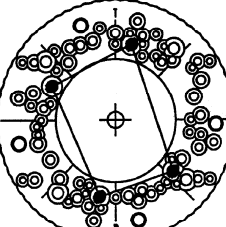
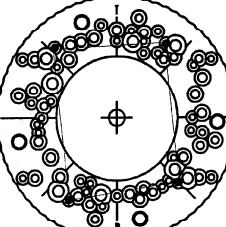
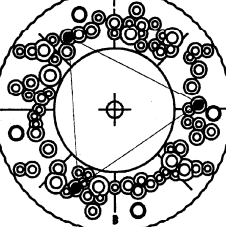
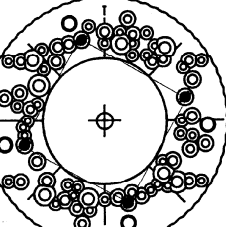
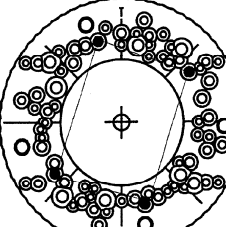
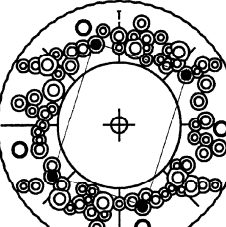
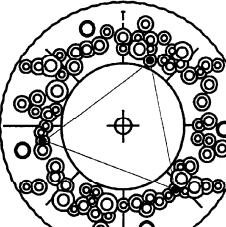
<p>FREUD FT2000</p> 	<p>HITACHI M12V</p> 	<p>HITACHI TR12</p> 	<p>MAKITA 3612B, 3600 MAKITA 3612-C</p> 
<p>MAKITA 3621BR & C</p> 	<p>MILWAUKEE</p> 	<p>PORTER CABLE 100, 536, 690, 691, 692, 693 MILWAUKEE PALM GRIP</p> 	<p>PORTER CABLE 518, 520, 7518/19, 7538/39 7529, 7536</p> 
<p>RYOBI 180</p> 	<p>RYOBI RE-600 (NEW)</p> 	<p>RYOBI RE-600 (OLD), 500,501</p> 	<p>SEARS CRAFTSMAN (3 HOLE)</p> 
<p>SEARS CRAFTSMAN (4 HOLE)</p> 	<p>SEARS CRAFTSMAN (4 HOLE)</p> 	<p>SEARS CRAFTSMAN (4 HOLE)</p> 	<p>BLACK AND DECKER 7614-04 (TYPE 1)</p> 

Router Hole Patterns (continued)

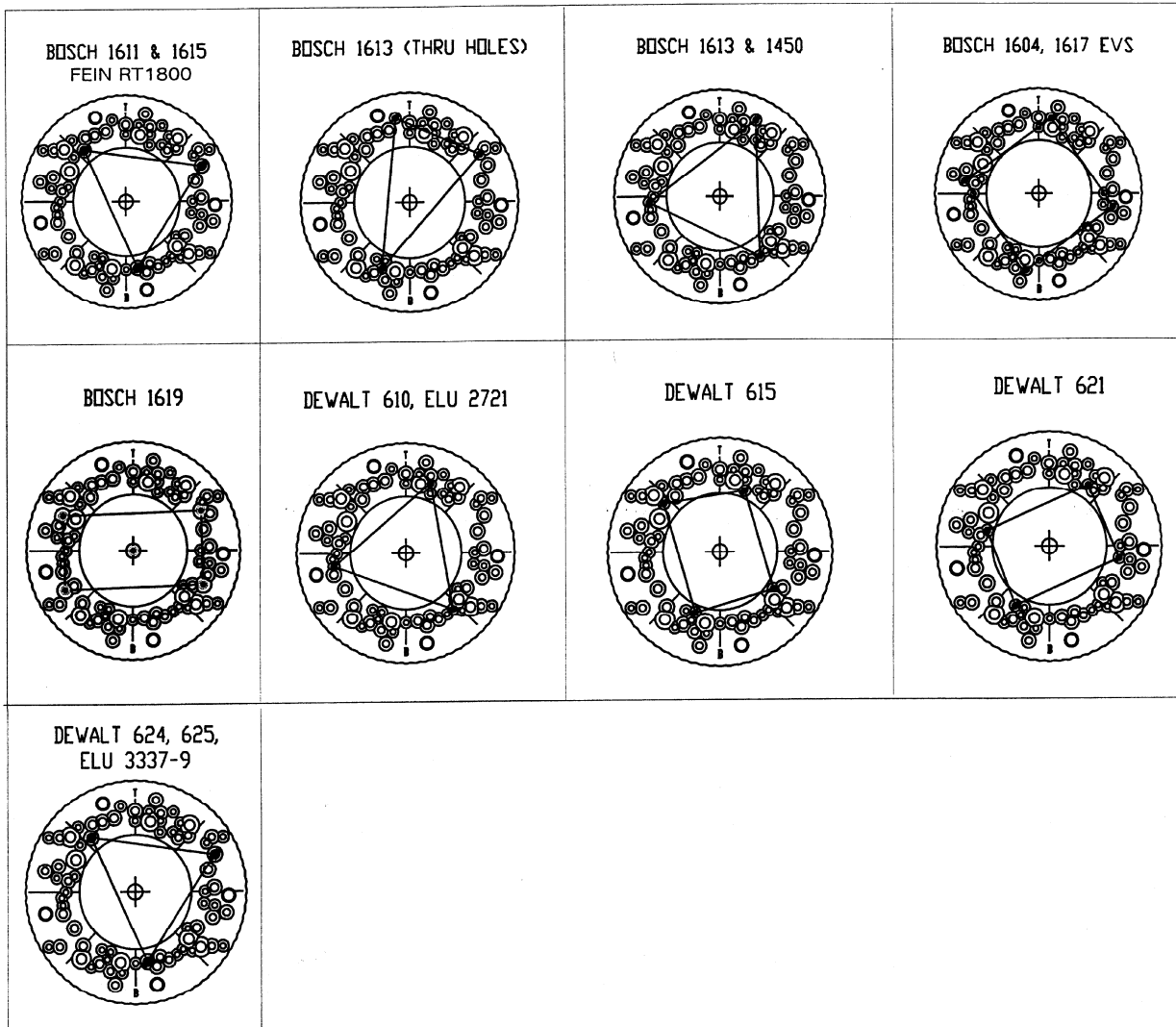

Making a Cut-out for the Rout-R-Lift

Extension tables are available from Powermatic that mount to a table saw and contain an opening designed specifically for the Rout-R-Lift. If you wish to make your own opening in a table, turn the Rout-R-Lift plate over, and use it as a template to draw the lines for the cutout. Be sure to rout a recess 3/8" deep, or slightly deeper.



427 New Sanford Rd.
LaVergne, TN 37086
Phone: 800-274-6848
www.powermatic.com